



Targan

Dual Band GSM Stubby Antenna

Features

- ◆ Groundplane Dependent
- ◆ Covers 900 and 1800 MHz bands
- ◆ SMA or FME connector options
- ◆ Ideal for fixed and mobile terminals

Specifications

Radiating element	1/4 Wave Element
Frequency range	900/1800 MHz
Peak gain	1.0 dBi
Polarisation	Linear
Return loss	-6.5 dB
Power rating	10W
Connector	SMA-Male RA, SMA-Male Straight, FME-Female RA
Dimensions	54 x 8mm (plus connector)

Popular Ordering Options

FTA35011-SM-RA	Targan with SMA-Male RA connector
FTA35011-SM-ST	Targan with SMA-Male ST connector

Specifications subject to change without notice.

5 Little Balmer
Buckingham Industrial Park
Buckingham
MK18 1TF
UK

Tel: +44 (0)1280 825044
Fax: +44 (0)1280 817179
Email: sales@ead-ltd.com
Web: www.ead-ltd.com



Targan| Dual Band GSM Stubby Antenna

Return Loss

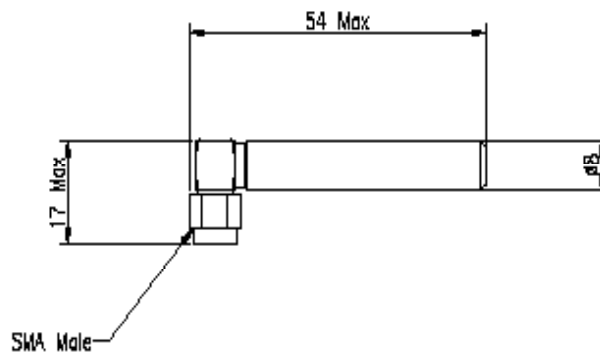
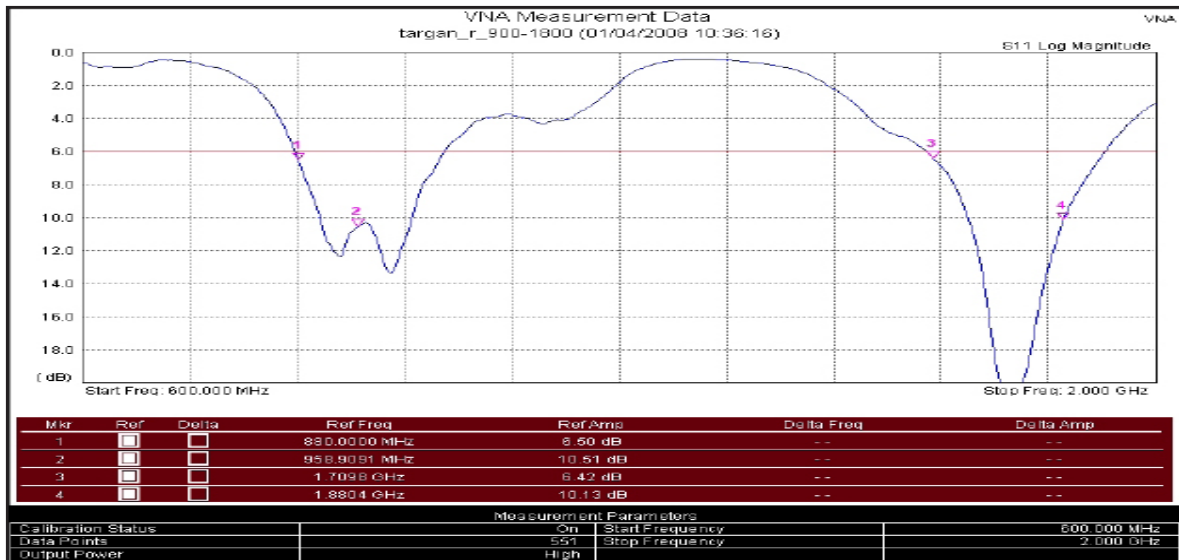

Specifications subject to change without notice.

5 Little Balmer
Buckingham Industrial Park
Buckingham
MK18 1TF
UK

Tel: +44 (0)1280 824055
Fax: +44 (0)1280 817179
Email: sales@ead-ltd.com
Web: www.ead-ltd.com